

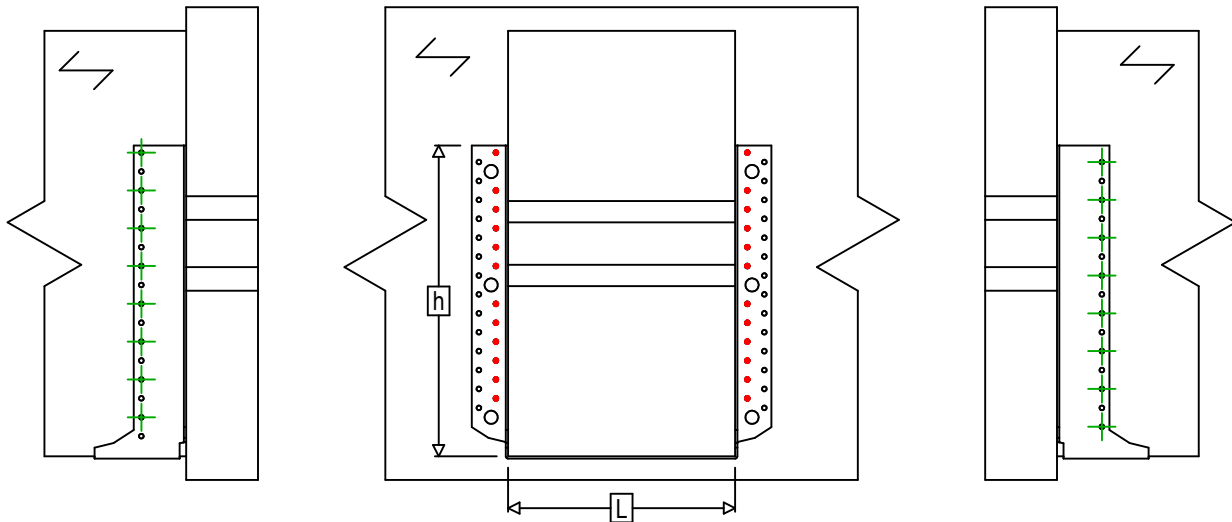

Artikelbezeichnung =	GLE900AL		
Verbindungsmittel =	Holz an Holz	Nebenträger an Hauptträger	
Verbindertyp =	Teilausnagelung		

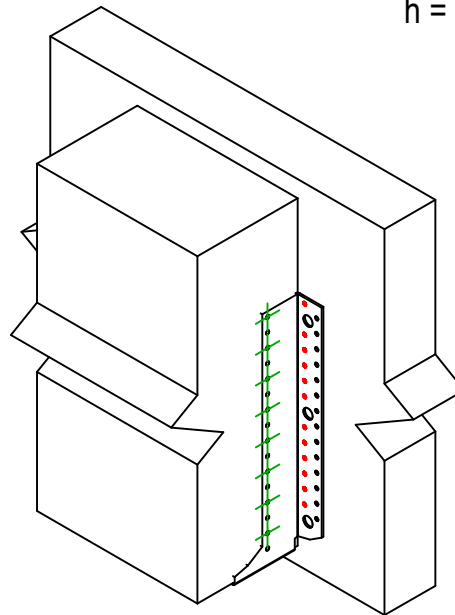

$$h = (900 - L) / 2$$



Verbindungsmittel am Hauptträger	Symbol	Verbindungsmittel	Verbindungsmittel		Anz.	
		CNA		CNA4.0X35 / CNA4.0X50		24
CSA			CSA5.0X35 / CSA5.0X40			
-		-	-			
Verbindungsmittel am Nebenträger	Symbol	Verbindungsmittel	L < 64mm	L > 64mm	Anz.	
		CNA		CNA4.0X35	CNA4.0X50	16
		CSA		CSA5.0X35	CSA5.0X40	