

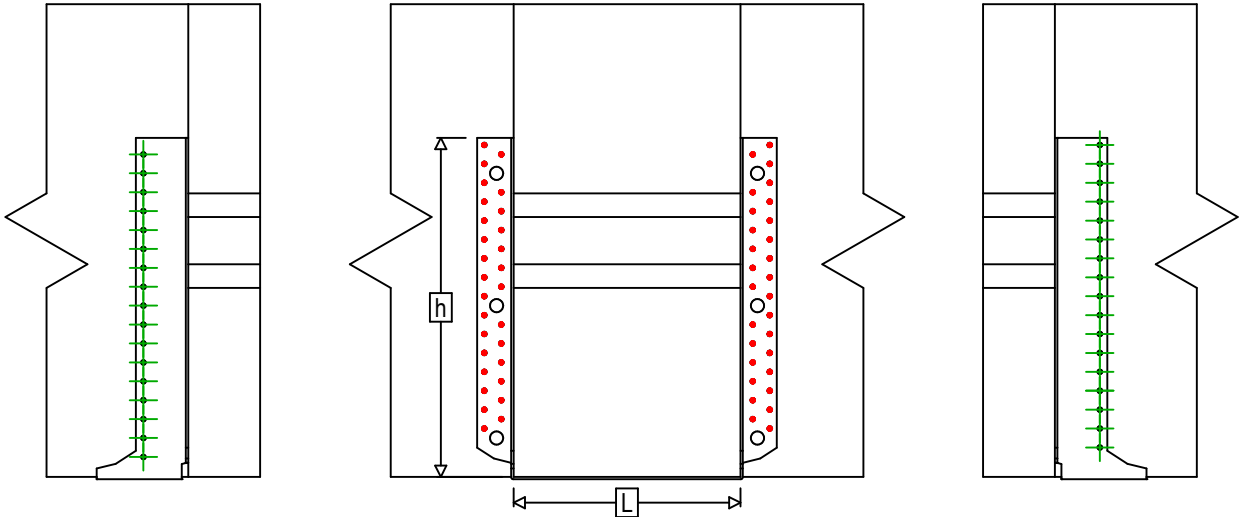

| | | | |
|----------------------|-----------------|----------------------------|--|
| Artikelbezeichnung = | GLE960AL | | |
| Verbindungsmittel = | Holz an Holz | Nebenträger an Hauptträger | |
| Verbindertyp = | Vollausnagelung | | |

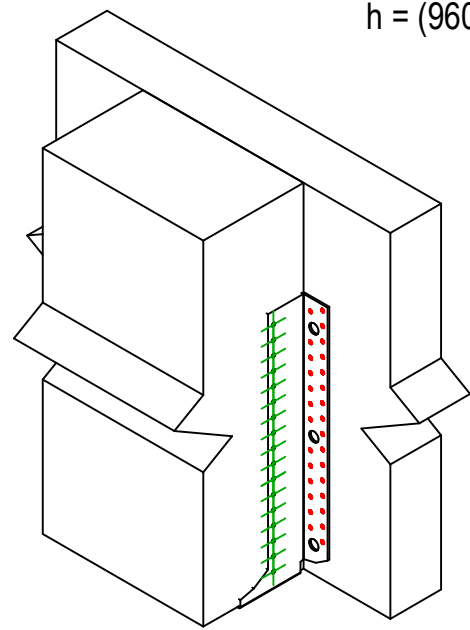

$$h = (960 - L) / 2$$



| Verbindungsmittel am Hauptträger | Symbol | Verbindungsmittel | Verbindungsmittel | | Anz. | |
|----------------------------------|--------|-------------------|-------------------|-----------------------|-----------|----|
| | | CNA | | CNA4.0X35 / CNA4.0X50 | | 58 |
| | | CSA | | CSA5.0X35 / CSA5.0X40 | | |
| - | | - | - | | | |
| Verbindungsmittel am Nebenträger | Symbol | Verbindungsmittel | L < 64mm | L > 64mm | Anz. | |
| | | CNA | | CNA4.0X35 | CNA4.0X50 | 34 |
| | | CSA | | CSA5.0X35 | CSA5.0X40 | |