

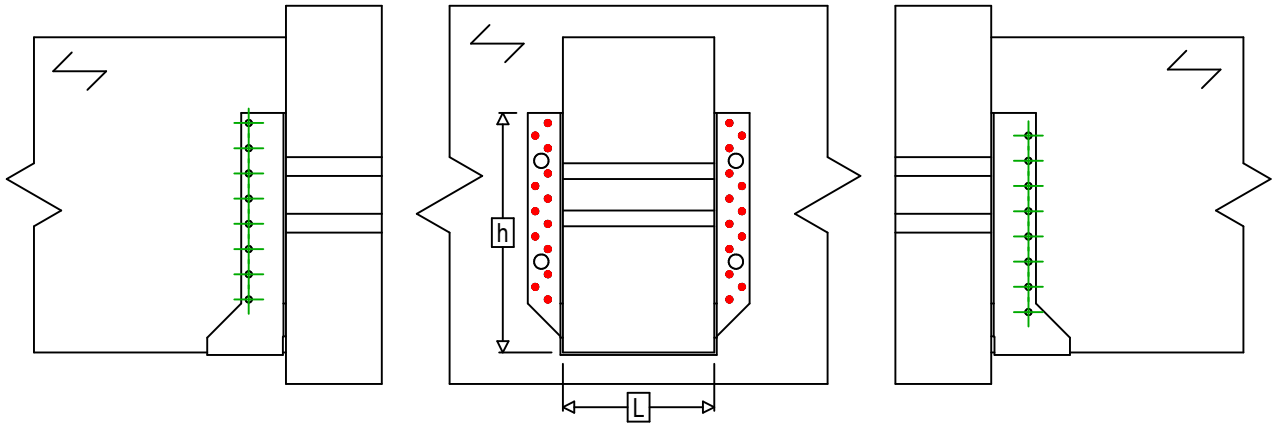

Art. Nr.	=	BSNN500	
Fastgørelsesmidler	=	Træ til træ	Bjælke til bjælke
Type af fastgørelse	=	Fuld udsømning	

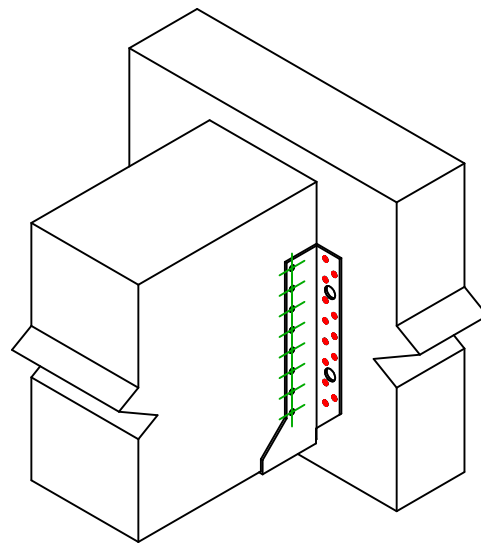

$$h = (500 - L) / 2$$



Fastgørelsesmidler i hovedbjælke	Symbol	Fastgørelsesmidler	Fastgørelsesmidler		Antal	
		CNA		CNA4.0X35 / CNA4.0X50		26
		CSA		CSA5.0X35 / CSA5.0X40		
-		-	-			
Fastgørelsesmidler i sekundær bjælke	Symbol	Fastgørelsesmidler	L < 64mm	L > 64mm	Antal	
		CNA		CNA4.0X35	CNA4.0X50	16
		CSA		CSA5.0X35	CSA5.0X40	