

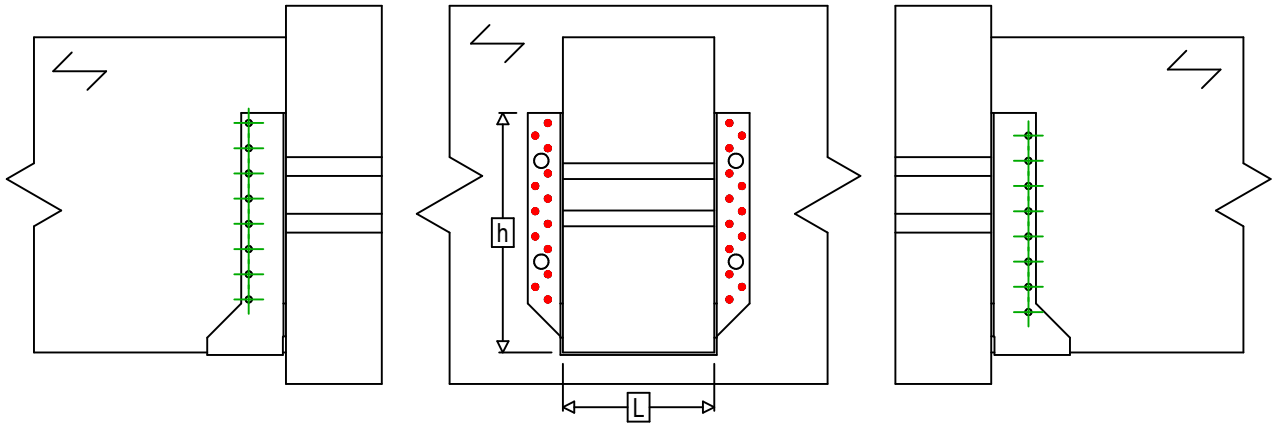

Referencia	=	BSNN500	
Fijaciones	=	Madera sobre madera	Viga sobre viga
Sistema de fijación	=	Clavado total	

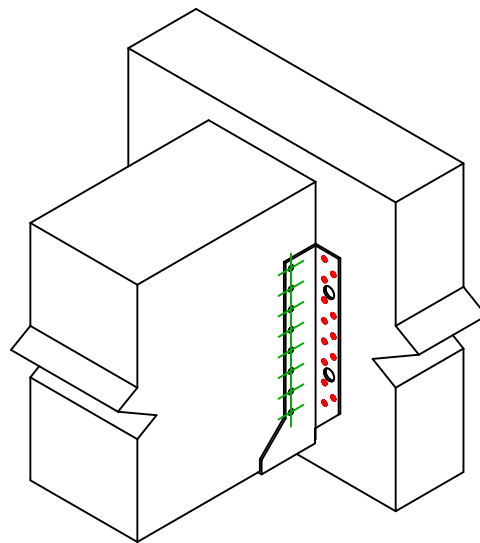

$$h = (500 - L) / 2$$



Fijaciones Soporte	Símbolo	Fijaciones	Fijaciones		Ctd		
		CNA		CNA4.0X35 / CNA4.0X50		26	
CSA			CSA5.0X35 / CSA5.0X40				
-		-	-				
Fijaciones Viga Secundaria	Símbolo	Fijaciones	L < 64mm	L > 64mm	Ctd		
		CNA		CNA4.0X35		CNA4.0X50	16
		CSA		CSA5.0X35		CSA5.0X40	