

SIMPSON**Strong-Tie**

Bevestigingspatroon



REV

0

REV DATE

22/07/24

DWG NAME

C_BSIN340_2D0_NP_JTB-FN-NL

Art. Nr.

=

BSIN340

Bevestigingsmiddelen

=

Hout op hout

Balk op draagbalk

Type bevestiging

=

Volledige vernageling

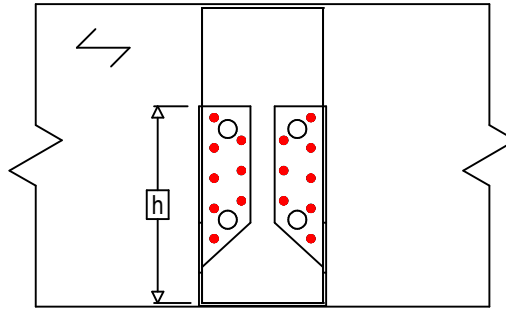
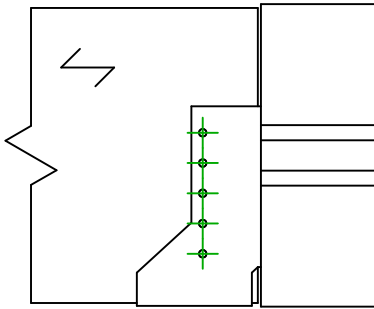

$$h = (340 - L) / 2$$

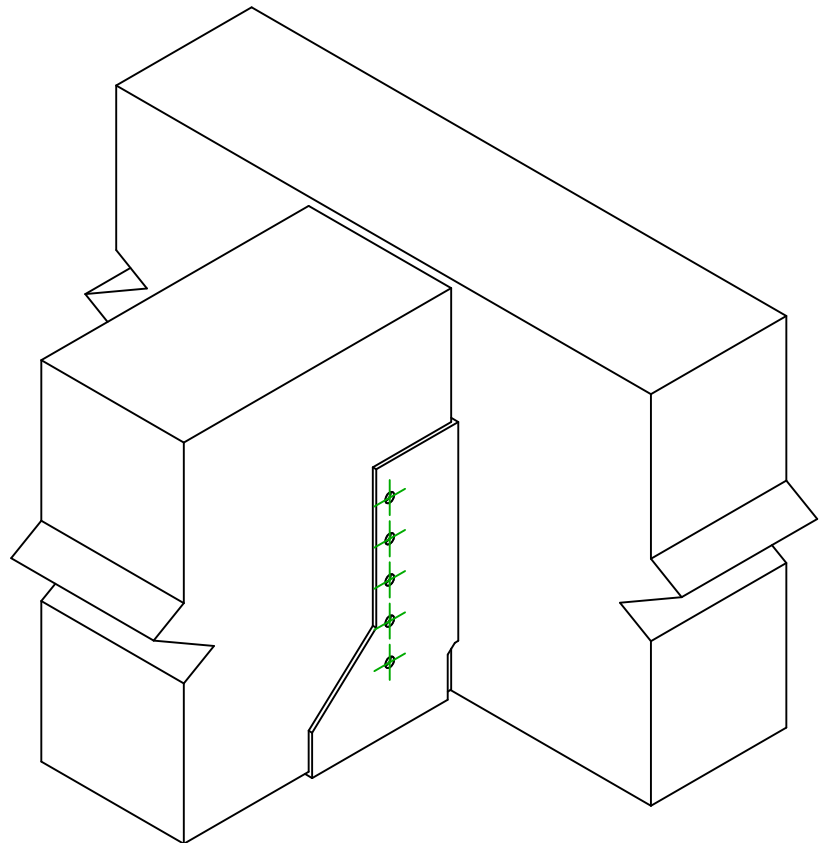
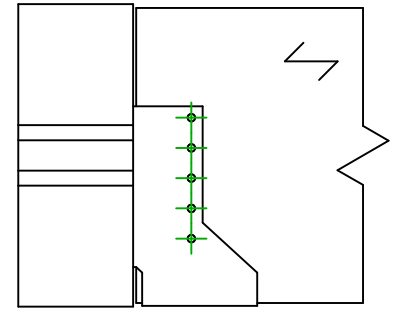
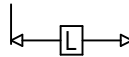



Symbol

Bevestigingsmiddelen

Bevestigingsmiddelen

Aantal

Draagbalk
BevestigingenCNA  

CNA4.0X35 / CNA4.0X50

CSA  

CSA5.0X35 / CSA5.0X40

16

-

-

Symbol

Bevestigingsmiddelen

L < 64mm

L > 64mm

Aantal

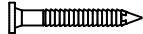
Balk
bevestiging(en)CNA  

CNA4.0X35

CNA4.0X50

CSA  

CSA5.0X35

CSA5.0X40

10